

## PEXP256T-20-2

### Premium Efficient Explosion Proof Motor

Class I, Division I, Groups C & D and Class II, Division I, Groups E, F and G - Operating Temperature Code: T3C

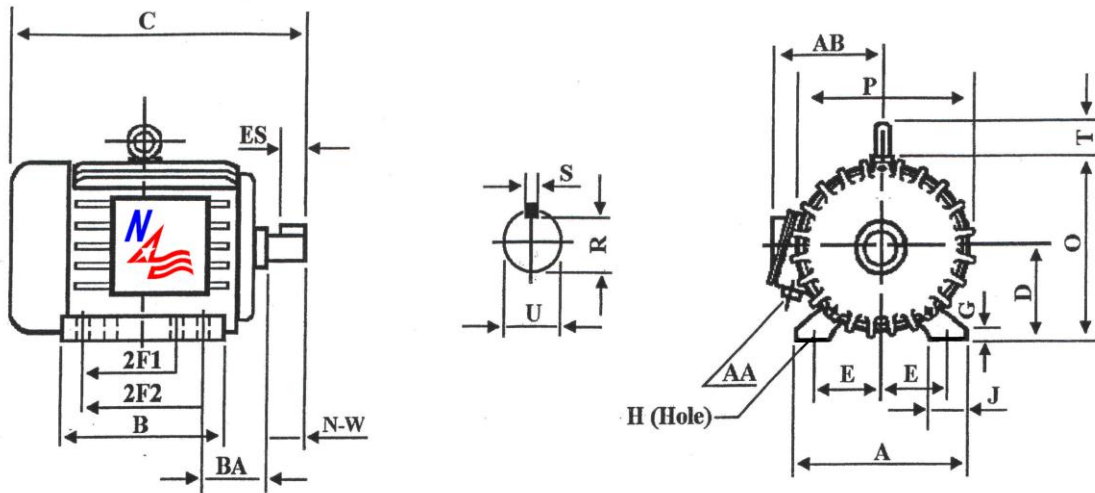

#### DIMENSIONS – INCHES

A	B	C	D	E	2F1	2F2	G	H	J	O
12.5	12.5	26.2	6.25	10	8.25	10	0.9	0.5	2.8	13.4
P	R	S	T	U	ES	AA	AB	BA	N-W	Mount
14.1	1.416	0.375	2.4	1.625	2.91	1.25	13.6	4.25	4	F1

#### PERFORMANCE DATA

Three Phase – 60Hz - 208-230/460V – NEMA Design B – Max. Ambient: 40° C

HP	Speed	Frame	NEMA Code	Efficiency (%)			Power Factor			Torque (ft-lb)		
				100%	75%	50%	100%	75%	50%	FLT	BDT%	LRT%
20	3531	256T	G	91.0	92.8	92.8	88.0	89.8	85.1	29.9	200	130
Amps ( 460V)		DE Bearing	ODE Bearing	Insulation Class	Enclosure Type	Service Factor	Weight (lbs)					
FLA	LRA											
22.8	145	6309	6309	F	TEFC	1.15	434					



**ElectricalHelper**

"Practical Straight Forward Electrical Wiring Solutions Since 1928."

For Fast Friendly Assistance  
Call Us 888.226.4917  
Hours 8:00AM - 5:00PM