

PEXP365T-75-4

Premium Efficient Explosion Proof Motor

Class I, Division I, Groups C & D and Class II, Division I, Groups E, F and G - Operating Temperature Code: T3C

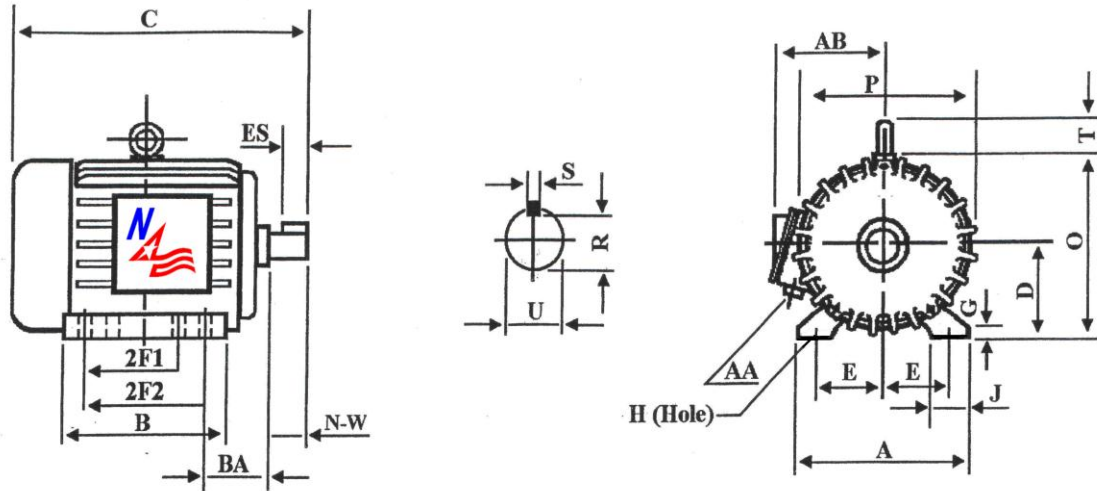

DIMENSIONS – INCHES

A	B	C	D	E	2F1	2F2	G	H	J	O
18	16.2	35.5	9	14	11.25	12.25	1.1	0.7	3	19
P	R	S	T	U	ES	AA	AB	BA	N-W	Mount
19.5	2.021	0.625	2.5	2.375	4.28	3	16.5	5.88	5.88	F1

PERFORMANCE DATA

Three Phase – 60Hz - 208-230/460V – NEMA Design B – Max. Ambient: 40° C

HP	Speed	Frame	NEMA Code	Efficiency (%)			Power Factor			Torque (ft-lb)		
				100%	75%	50%	100%	75%	50%	FLT	BDT%	LRT%
75	1786	365T	G	95.4	95.3	94.5	85.0	90.4	85.6	220.6	200	140
Amps (460V)		DE Bearing	ODE Bearing	Insulation Class	Enclosure Type	Service Factor	Weight (lbs)					
FLA	LRA											
86.5	542.5	6314	6314	F	TEFC	1.15	957					



ElectricalHelper

"Practical Straight Forward Electrical Wiring Solutions Since 1928."

For Fast Friendly Assistance
Call Us 888.226.4917
Hours 8:00AM - 5:00PM