

SS56C3/4M-6

WASHDOWN DUTY MOTOR

HIGH EFFICIENCY / EISA COMPLIANT

STAINLESS STEEL CONSTRUCTION - C-FLANGE WITH FEET

TOTALLY ENCLOSED FAN COOLED - IP66 CONSTRUCTION

INVERTER DUTY 10:1 CT; 20:1 VT - NEMA MG1 PART 31

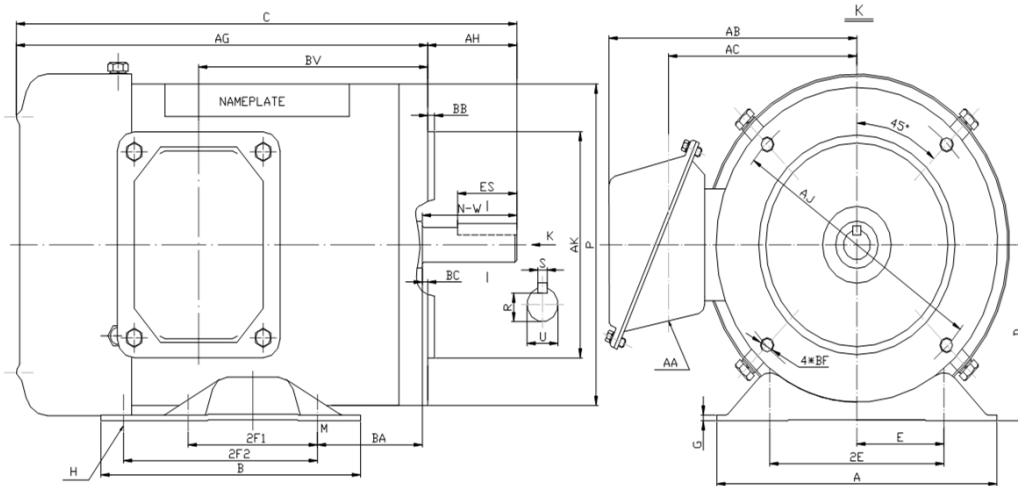

DIMENSIONS

HP	RPM	Frame	Mounting													
			A	B	C	D	G	H	E	2E	2F1	2F2	P	AK	AJ	AH
3/4	1200	56C	6.50	5.00	11.59	3.50	0.12	1.22*0.34	2.44	4.88	3.00	0.00	6.50	4.500	5.875	2.06

Mounting					Shaft Extension, Key Set					Conduit Box				Bearings		Mount
AG	BA	BB	BC	BF	U	R	S	ES	N-W	AA	AB	AC	BV	DE	ODE	
9.53	2.75	0.16	-0.19	4*3/8-16	0.625	0.517	0.188	1.41	1.88	0.86	5.75	4.25	5.30	6205	6205	F1

BEARING LUBRICATION: The bearings come lubricated with Mobile Polyrex EM Polyurea Grease.



Murphey Electric LLC

Serving Industry With The Best Products And Service Since 1928

411 Platte Ave.
York, NE. 68467

Phone: 402-362-3245
Toll Free / Fax: 888-226-4917



SS56C3/4M-6

WASHDOWN DUTY MOTOR
HIGH EFFICIENCY / EISA COMPLIANT
STAINLESS STEEL CONSTRUCTION - C-FLANGE WITH FEET
TOTALLY ENCLOSED FAN COOLED - IP66 CONSTRUCTION
INVERTER DUTY 10:1 CT; 20:1 VT - NEMA MG1 PART 31

PERFORMANCE DATA

HP	RPM	Frame	Voltage	Frequency (Hz)	Full Load S.F.	Insulation Class	NEMA Design	Slip (%)	NEMA Code	Enclosure Type	IP Rating	Max. Ambient
3/4	1155	56C	208-230/460	60	1.15	F	C	3.8	K	TEFC	66	40° C

Amps (460V)		Efficiency (%)				Power Factor			Torque (ft-lb)			DE Bearing	ODE Bearing	Connection	Weight (lbs.)
FLA	LRA	100%	75%	50%	Min.	100%	75%	50%	FLT	LRT %	BDT %				
1.9	12.5	80.0	76.0	71.0	77.0	0.65	0.58	0.50	3.3	255	280	6205	6205	9 Lead 2Y/Y	35

NAME PLATE

		WASHDOWN DUTY STAINLESS STEEL MOTOR				CONNECTION DIAGRAMS					
INVERTER DUTY 20:1 VT; 10:1 CT				HIGH EFFICIENCY EISA COMPLIANT							
CAT NO: SS56C3/4M-6		FRAME 56C		PHASE 3							
HZ 60	S.F. 1.15	HZ 50	S.F. 1.2	ENCL TEFC	IP 66						
HP 3/4	RPM 1155	HP 1/2	RPM 955	DUTY CONT	DES C						
VOLTS 208-230/460		VOLTS 190/380		AMB 40° C	INS F						
FLA 4.1 - 3.7 / 1.85	FLA 2.8/1.4		DE BEARING 6205								
CODE K	P.F. 0.65	CODE K	P.F. 0.67	ODE BEARING 6205							
EFF 80.0	MIN 77.0	EFF 77	MIN 74	LUB: Mobile Polyrex EM							
MOTOR WEIGHT 35 LBS		CONNECTION 9 Lead 2Y/Y		SER NO							
Special purpose motor designed for washdown applications and extremely corrosive environments. Hernando, Mississippi										CC 082A	

APPLICATIONS:

Applications include washdown applications, food processing, chemical processing, pharmaceuticals, poultry processing, meat processing, dairy applications, bakeries, snack foods, bottling and extremely corrosive environments.



Murphey Electric LLC
 Serving Industry With The Best Products And Service Since 1928

411 Platte Ave.
 York, NE. 68467

Phone: 402-362-3245
 Toll Free / Fax: 888-226-4917